

FEATURES

- Subminiature Design
- Bifurcated Crossbar Contacts
- 0.300" 16 Pin DIL Package
- Meets FCC part 68 Voltage Surge



UL / CUL Ratings

Contact Form	2 Form C, DPDT (Crossbar Contacts)	
Rated Load	Voltage	Amps
Resistive, 6K cycles, 40°C	24VDC	1A
NO, Resistive, 6K cycles, 65°C	30VDC	2A
Resistive, 6K cycles, 40°C	120VAC	.5A

CHARACTERISTICS

Insulation Resistance	100MΩ min. at 500 VDC
Dielectric Strength	1000V rms, between contacts
	1500V rms, between coil & contacts
Surge Withstand Voltage	1500V, between open contacts
FCC part 68	1500V between contact poles
	1500V between coil & contacts
Power Consumption	.15 W, .20W
Terminal Strength	5N
Solderability	260°C 5 s ± 0.5 s
Operating Temperature	-40°C to 85°C
Storage Temperature	-40°C to 155°C
Shock Resistance	100 m/s ² 11 ms
Vibration Resistance	10-40 Hz double amplitude 1.5mm
Weight	4.5g

CONTACT DATA

Maximum Switching Power	60W, 75VA	
Maximum Switching Voltage	48VDC, 250VAC	
Maximum Switching Current	3A	
Material	AgNi+Au (clad)	
Initial Contact Resistance	50 mΩ max.	
Service Life	Mechanical	1 x 10 ⁷ operations
	Electrical	1 x 10 ⁵ operations

ORDERING INFORMATION

Example	PC323	-12	H	-X
Model:	PC323			
Coil Voltage	5 = 5VDC			
	9 = 9VDC			
	12 - 12VDC			
	24 = 24VDC			
	48 = 48VDC			
Contact Material:	Nil = AgNi + Au			
Coil Sensitivity:	L = .15W			
	H = .20W			
RoHS Compliant:	X = RoHS Compliant			

Values can change due to the switching frequency, desired reliability levels, environmental conditions, and in-rush current levels. It is recommended to test to actual load conditions for the application. It is the users responsibility to determine the performance suitability for their specific application. The use of any coil voltage less than the rated coil voltage may compromise the operation of the relay.

COIL DATA

Coil Voltage		Resistance (Ohms ± 10%)		Pick Up Voltage Max. VDC	Release Voltage Min. VDC	Coil Power W	Operate Time ms	Release Time ms
Rated	Maximum	.15W	.20W					
5	6.5	167	125	2.25	.5	.15 .20	4.5	1.5
9	11.7	540	405	6.75	.9			
12	15.6	960	720	9.00	1.2			
24	31.2	3840	2880	18.00	2.4			
48	62.4	n/a	11500	36.00	4.8			

DIMENSIONS mm (inches)

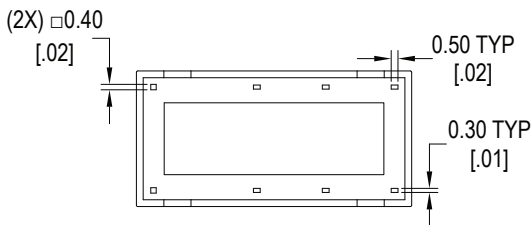
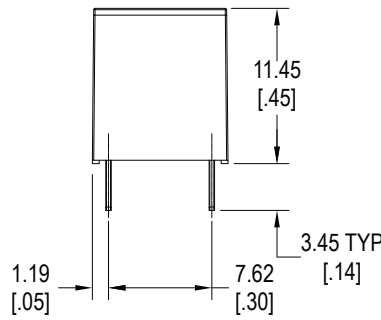
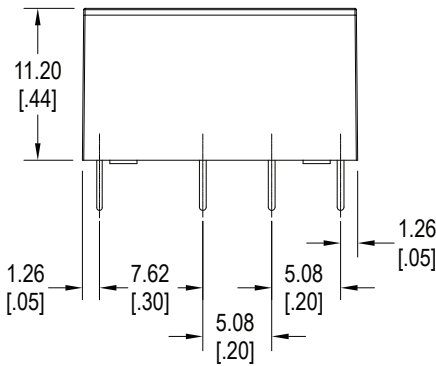
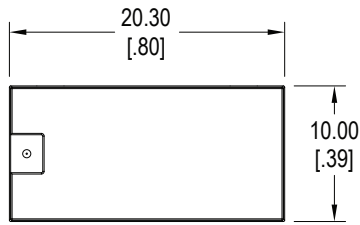

SCHEMATICS & PC LAYOUT Bottom Views

